



aerospace  
climate control  
electromechanical  
filtration  
fluid & gas handling  
hydraulics  
pneumatics  
process control  
sealing & shielding



# LF 3600 Nickel-Plated Brass Instant Fittings

One fitting for all industrial applications!



ENGINEERING YOUR SUCCESS.

**NEW AND IMPROVED**



Welding

Tooling

Painting lines

Meat processing

Automotive process



Food process

Coffee machines

Medical equipment

**Printing machines**

### Enhanced technical performance fittings

- > Now resist up to 150°C at 30 bar!
- > Excellent resistance to high pressure and vacuum
- > An HACCP\*-improved product with particularly long threads to resist shocks, stress and vibrations
- > Spring collet gripping for long-term resistance
- > Excellent resistance to abrasion and corrosion due to high phosphorus chemical nickel plating
- > Full flow passage, minimal pressure drop

### Suitable for many specialized applications

- > Can even be used in the food industry
- > Materials conform to FDA standards and to European Regulation 1935/2004/EC

### Time-saving and easy-to install

- > Instant manual connection and disconnection

### Extremely compact

- > Overall dimensions are small
- > Interconnectability allows for specific combinations

### Unit quality control and dating and traceability of products

- > Guarantees quality

### The widest range on the market

- > More than 250 part numbers

\* HACCP : Hazard Analysis Critical Control Point

## > Technical Specifications

<b>Suitable Fluid</b>	All fluids and gases compatible with the fitting materials. Examples: compressed air, grease, water, food...
<b>Working Pressure</b>	<b>30 bar</b> (limited to 20 bar for compact swivel elbows 3699, 3609)
<b>Working Temperature</b>	<b>-20°C to +150°C</b>
<b>Vacuum</b>	<b>99% (755mmHg)</b>

## > Maximum tightening torque for LF 3600, BSPP and metric threads

	Thread	DaN.m
Maximum tightening torque for LF 3600, BSPP and metric threads	M5x0,8	0,16 DaN.m
	G1/8	0,8 DaN.m
	G1/4	1,2 DaN.m
	G3/8	3 DaN.m
	G1/2	3,5 DaN.m

## > Tubing

- Polyurethane tubing
- Polyamide tubing
- Polyethylene and fluoropolymer FEP tubing
- Anti-spark tubing

## > How to recognize the new generation

The note 150° is mentioned on the packaging label.

OLD NEW

The new seal is dark brown.

The letter P is written on the collet.

**Caution** : for use at +150°C, 30 bar, it is the user's responsibility to check that the new generation of LF 3600 is indeed used.

## > Regulations

The LF 3600 instant fittings conform to the following standards:



All materials in contact with food are in compliance with the American Food and Drug Administration.



All materials in contact with food are in compliance with the European Regulation 1935/2004/EC (minimum flow 0,02 l/h)



NSF H1 grease



Reduction of Hazardous Substances – 2002/95/EC. All products shown in this catalogue are RoHS-certified

### Other compliances:

- DIN 73378: polyamide tubing for use in motor vehicles
- UL 94 V0
- ASTM B733 - 04: for autocatalytic (electroless) nickel-phosphorus coatings on metal
- European Directive ATEX: for devices used in potentially explosive atmospheres

> Our instant fittings are guaranteed silicone-free

# Threaded Fittings

## 3675 Male stud, BSPT thread

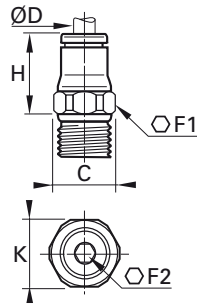

ØD	C		F1	F2	H	K	
4	R1/8	3675 04 10	10	3	15	11	0,009
4	R1/4	3675 04 13	14	3	15	15	0,018
6	R1/8	3675 06 10	13	4	17	14	0,014
6	R1/4	3675 06 13	14	4	17	15	0,019
8	R1/8	3675 08 10	15	5	19	16	0,016
8	R1/4	3675 08 13	15	6	18	16	0,020
8	R3/8	3675 08 17	17	6	18,5	18,5	0,031
10	R1/4	3675 10 13	18	7	23	19,5	0,027
10	R3/8	3675 10 17	18	8	22,5	19,5	0,035
10	R1/2	3675 10 21	22	8	22,5	24	0,057
12	R1/4	3675 12 13	20	7	25,5	22	0,037
12	R3/8	3675 12 17	20	9	24	22	0,035
12	R1/2	3675 12 21	22	10	23	24	0,051
14	R3/8	3675 14 17	22	9	27	24	0,055
14	R1/2	3675 14 21	24	11	26	26	0,063

## 3601 Male stud, BSPP and metric thread

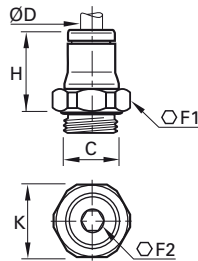

ØD	C		F1	F2	H	K	
4	M5x0,8	3601 04 19	10	2,5	15,5	11	0,006
4	G1/8	3601 04 10	13	3	14,5	14	0,009
4	M6x1	3601 04 52	10	3	16	11	0,007
4	G1/4	3601 04 13	16	3	14,5	17,5	0,015
4	M8x1	3601 04 56	11	3	14,5	12	0,007
6	M5x0,8	3601 06 19	13	2,5	19	14	0,010
6	G1/8	3601 06 10	13	4	17,5	14	0,011
6	M10x1	3601 06 60	13	4	17,5	14	0,010
6	G1/4	3601 06 13	16	4	17	17,5	0,016
8	G1/8	3601 08 10	15	5	20	16	0,015
8	G1/4	3601 08 13	16	6	18	17,5	0,014
8	G3/8	3601 08 17	20	6	19	22	0,028
10	G1/4	3601 10 13	18	7	25	19,5	0,026
10	G3/8	3601 10 17	20	8	22,5	22	0,029
10	G1/2	3601 10 21	24	8	22,5	26	0,045
12	G1/4	3601 12 13	20	7	26,5	22	0,032
12	G3/8	3601 12 17	20	9	26	22	0,037
12	G1/2	3601 12 21	24	10	23,5	26	0,047
14	G3/8	3601 14 17	22	9	28	24	0,039
14	G1/2	3601 14 21	24	11	26,5	26	0,050

## 3681 Male stud, metric thread

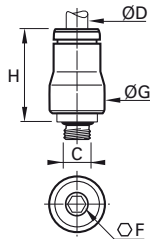

ØD	C		F	G	H	
4	M5x0,8	3681 04 19	2,5	10	16	0,005

## 3614 Female stud, BSPP and metric thread

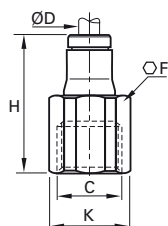

ØD	C		F	H	K	
4	M5x0,8	3614 04 19	10	22	11	0,011
4	G1/8	3614 04 10	14	25	15	0,016
4	G1/4	3614 04 13	17	29	18,5	0,026
6	G1/8	3614 06 10	14	27,5	15	0,019
6	G1/4	3614 06 13	17	31,5	18,5	0,029
8	G1/8	3614 08 10	15	28,5	16	0,022
8	G1/4	3614 08 13	17	32,5	18,5	0,032
10	G3/8	3614 10 17	22	38	24	0,053
12	G3/8	3614 12 17	22	39	24	0,056
12	G1/2	3614 12 21	24	43,5	26	0,063

# Threaded Fittings

## 3621 Male stud standpipe, BSPT thread

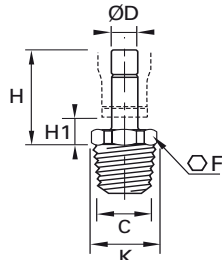

ØD	C		F	H	H1	K	⚖
4	R1/8	3621 04 10	10	21	7	11	0,007
4	R1/4	3621 04 13	14	21	7	15	0,014
6	R1/8	3621 06 10	10	23,5	6,5	11	0,008
6	R1/4	3621 06 13	14	23,5	6,5	15	0,015
8	R1/8	3621 08 10	10	24	6,5	11	0,008
8	R1/4	3621 08 13	14	24	6,5	15	0,016
10	R1/4	3621 10 13	14	22	6,5	15	0,018
10	R3/8	3621 10 17	17	30	7,5	18,5	0,029
12	R3/8	3621 12 17	17	31	7,5	18,5	0,024
12	R1/2	3621 12 21	22	38	7,5	24	0,041
14	R1/2	3621 14 21	22	33	8	24	0,042

## 3631 Male stud standpipe, BSPP and metric thread

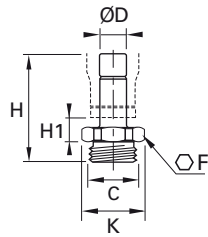

ØD	C		F	H	H1	K	⚖
4	M5x0,8	3631 04 19	13	25,5	7	14	0,003
4	G1/8	3631 04 10	16	25,5	7	17,5	0,007
4	G1/4	3631 04 13	8	26,5	7,5	8,7	0,011
6	G1/8	3631 06 10	13	28	6,5	14	0,008
6	G1/4	3631 06 13	16	29	6,5	17,5	0,012
8	G1/8	3631 08 10	13	28,5	6,5	14	0,009
8	G1/4	3631 08 13	16	29,5	6,5	17,5	0,013
8	G3/8	3631 08 17	20	30,5	7,5	22	0,021
10	G1/4	3631 10 13	16	34,5	6,5	17,5	0,017
10	G3/8	3631 10 17	20	35,5	7,5	22	0,023
10	G1/2	3631 10 21	24	37	7,5	26	0,029
12	G3/8	3631 12 17	20	36,5	7,5	22	0,021
12	G1/2	3631 12 21	24	38	7,5	26	0,031
14	G1/2	3631 14 21	24	40	8	26	0,031

## 3609 Male stud elbow, BSPT thread

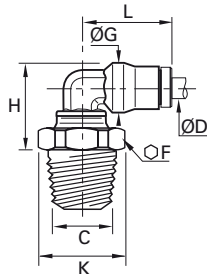

ØD	C		F	G	H	K	L	⚖
4	R1/8	3609 04 10	13	10	15	14	18	0,014
4	R1/4	3609 04 13	14	10	17	15	18	0,020
6	R1/8	3609 06 10	13	12	17,5	14	21,5	0,018
6	R1/4	3609 06 13	14	12	19	15	21,5	0,025
8	R1/8	3609 08 10	13	15	19,5	14	23,5	0,023
8	R1/4	3609 08 13	14	15	21	15	23,5	0,028
8	R3/8	3609 08 17	17	15	21	18,5	23,5	0,034
10	R1/4	3609 10 13	15	17,5	23,5	16	29	0,038
10	R3/8	3609 10 17	17	17,5	25,5	18,5	29	0,042
12	R1/4	3609 12 13	15	19,5	26	16	31	0,052
12	R3/8	3609 12 17	17	19,5	28,5	18,5	31	0,052
12	R1/2	3609 12 21	21	19,5	28,5	23	31	0,070
14	R3/8	3609 14 17	19	21,5	29	21	34	0,066
14	R1/2	3609 14 21	22	21,5	30	26	34	0,076

## 3699 Male stud elbow, BSPP and metric thread

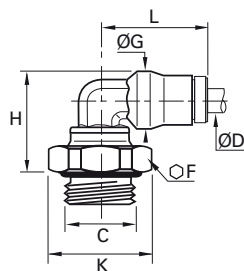

ØD	C		F	G	H	K	L	⚖
4	M5x0,8	3699 04 19	10	10	18	11	18	0,012
4	G1/8	3699 04 10	13	10	17	14	18	0,015
4	M6x1	3699 04 52	10	10	18	11	18	0,012
4	G1/4	3699 04 13	16	10	17,5	17,5	18	0,018
4	M8x1	3699 04 56	11	10	18	12	18	0,013
6	G1/8	3699 06 10	13	12	19	14	21,5	0,018
6	M10x1	3699 06 60	13	12	19	14	21,5	0,018
6	G1/4	3699 06 13	16	12	19,5	17,5	21,5	0,022
8	G1/8	3699 08 10	13	15	20,5	14	23,5	0,023
8	G1/4	3699 08 13	16	15	21,5	17,5	23,5	0,025
8	G3/8	3699 08 17	20	15	21,5	22	23,5	0,033
10	G1/4	3699 10 13	16	17,5	27	17,5	29	0,039
10	G3/8	3699 10 17	20	17,5	25,5	22	29	0,040
12	G1/4	3699 12 13	16	19,5	29,5	17,5	31	0,051
12	G3/8	3699 12 17	20	19,5	28,5	22	31	0,053
12	G1/2	3699 12 21	24	19,5	28,5	26	31	0,060
14	G3/8	3699 14 17	20	21,5	29	22	34	0,060
14	G1/2	3699 14 21	24	21,5	29,5	26	34	0,064

# Threaded Fittings

## 3698 Male stud branch tee, BSPP and metric thread

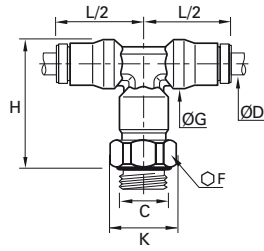

ØD	C		F	G	H	K	L/2	
4	M5x0,8	3698 04 19	10	10	27,5	11	18	0,020
4	G1/8	3698 04 10	13	10	25,5	14	18	0,021
6	G1/8	3698 06 10	13	12	31	14	21,5	0,033
6	G1/4	3698 06 13	16	12	30,5	17,5	21,5	0,034
8	G1/8	3698 08 10	14	15	33,5	15	23,5	0,041
8	G1/4	3698 08 13	16	15	34	17,5	23,5	0,045
10	G1/4	3698 10 13	18	17,5	42	19,5	29	0,066
12	G3/8	3698 12 17	20	19,5	46	22	31	0,100
14	G1/2	3698 14 21	24	21,5	49	26	34	0,109

## 3693 Male stud run tee, BSPP and metric thread

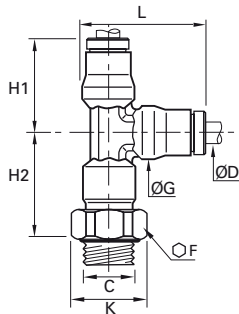

ØD	C		F	G	H1	H2	K	L	
4	M5x0,8	3693 04 19	10	10	18	22,5	11	23	0,020
4	G1/8	3693 04 10	13	10	18	20,5	14	23	0,021
6	G1/8	3693 06 10	13	12	21,5	25	14	28	0,033
6	G1/4	3693 06 13	16	12	21,5	24,5	17,5	28	0,033
8	G1/8	3693 08 10	14	15	23,5	26,5	15	31	0,041
8	G1/4	3693 08 13	16	15	23,5	26,5	17,5	31	0,045
10	G1/4	3693 10 13	18	17,5	29	33	19,5	37,5	0,066
12	G3/8	3693 12 17	20	19,5	31	36,5	22	40,5	0,100
14	G1/2	3693 14 21	24	21,5	34	38,5	26	45	1,129

## 3618 Single banjo, BSPP and metric thread

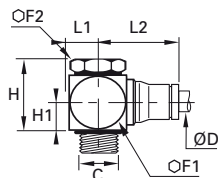

ØD	C		F1	F2	H	H1	L1	L2	
4	M5x0,8	3618 04 19	10	8	14,5	6,5	6	18,5	0,011
4	G1/8	3618 04 10	17	14	23	9,5	7,5	20,5	0,041
6	M5x0,8	3618 06 19	10	8	15	7	6	22,5	0,014
6	G1/8	3618 06 10	17	14	23	9,5	7,5	23,5	0,045
6	G1/4	3618 06 13	22	17	22	9	9	25,5	0,068
8	G1/8	3618 08 10	17	14	23	9,5	7,5	26	0,046
8	G1/4	3618 08 13	22	17	22	9	9	26,5	0,066
10	G3/8	3618 10 17	22	22	33	14	10	32	0,105

## 3600 Cartridge

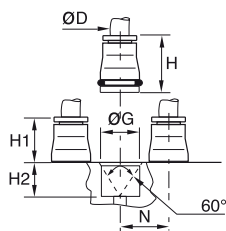

ØD		G	H	H1	H2	N	
4	3600 04 00	10	17	9	8,5	11	0,006
6	3600 06 00	12	19	11	8,5	13,5	0,009
8	3600 08 00	15	21	12,5	8,5	16	0,013
10	3600 10 00	17,5	24,5	14,5	10,5	20	0,020
12	3600 12 00	19,5	25	15	10,5	22,5	0,022
14	3600 14 00	22	28,5	16,5	12	25	0,032

Please consult us for detailed drawings of cavity dimensions and tolerances.

# Threaded Fittings

## 3629 Extended stud elbow, BSPT

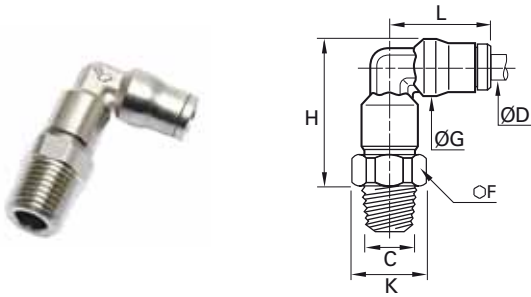

ØD	C		F	G	H	K	L	
4	R1/8	3629 04 10	10	10	24,5	11	18	0,016
6	R1/8	3629 06 10	13	12	29,5	14	21,5	0,025
6	R1/4	3629 06 13	14	12	30,5	15	21,5	0,031
8	R1/8	3629 08 10	14	15	32,5	15	23,5	0,031
8	R1/4	3629 08 13	14	15	34	15	23,5	0,036
10	R1/4	3629 10 13	18	17,5	39	19,5	29	0,053

## 3669 Extended male stud elbow, BSPP and metric thread

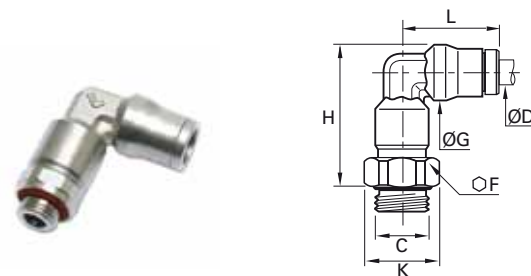

ØD	C		F	G	H	K	L	
4	M5x0,8	3669 04 19	10	10	27,5	11	18	0,015
4	G1/8	3669 04 10	13	10	25,5	14	18	0,017
6	G1/8	3669 06 10	13	12	31	14	18	0,023
6	G1/4	3669 06 13	16	12	30,5	17,5	21,5	0,028
8	G1/8	3669 08 10	14	15	33,5	15	23,5	0,031
8	G1/4	3669 08 13	16	15	34	17,5	23,5	0,036
10	G1/4	3669 10 13	18	17,5	42	19,5	29	0,053
10	G3/8	3669 10 17	20	17,5	41	22	29	0,056
12	G1/4	3669 12 13	20	19,5	47	22	31	0,075
12	G3/8	3669 12 17	20	19,5	46	22	31	0,072
14	G1/2	3669 14 21	24	22	49	26	34	0,094

## 3608 Male stud branch tee, BSPT thread

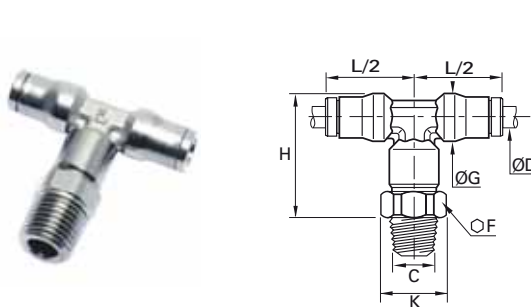

ØD	C		F	G	H	K	L/2	
4	R1/8	3608 04 10	10	10	24,5	11	18	0,020
6	R1/8	3608 06 10	13	12	29,5	14	21,5	0,031
6	R1/4	3608 06 13	14	12	30,5	15	21,5	0,041
8	R1/8	3608 08 10	14	15	32,5	15	23,5	0,041
8	R1/4	3608 08 13	14	15	34	15	23,5	0,048
10	R1/4	3608 10 13	18	17,5	39	19,5	29	0,070
10	R3/8	3608 10 17	18	17,5	41	19,5	29	0,074
12	R3/8	3608 12 17	20	19,5	46,5	22	31	0,103
14	R1/2	3608 14 21	22	21,5	50,5	26	34	0,142

## 3603 Male stud run tee, BSPT thread

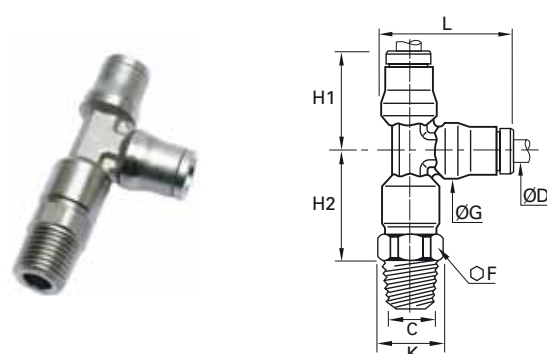

ØD	C		F	G	H1	H2	K	L	
4	R1/8	3603 04 10	10	10	18	19,5	11	23	0,020
6	R1/8	3603 06 10	13	12	21,5	23,5	14	28	0,031
6	R1/4	3603 06 13	14	12	21,5	24,5	15	28	0,041
8	R1/8	3603 08 10	14	15	23,5	25	15	31	0,041
8	R1/4	3603 08 13	14	15	23,5	26,5	15	31	0,048
10	R1/4	3603 10 13	18	17,5	29	30,5	19,5	37,5	0,070
10	R3/8	3603 10 17	18	17,5	29	32,5	19,5	37,5	0,074
12	R3/8	3603 12 17	20	19,5	31	36,5	22	40,5	0,103
14	R1/2	3603 14 21	22	21,5	34	40	24	45	0,142

# Bulkhead Connectors and Tube-to-Tube Fittings

## 3616 Equal bulkhead connector

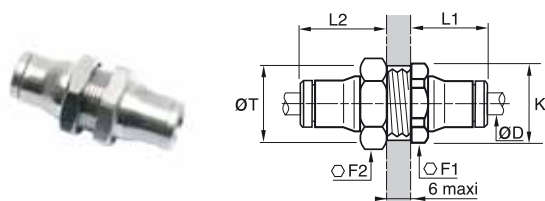

ØD		F1	F2	K	L1	L2	T	
4	3616 04 00	13	14	14	14	20	12,5	0,019
6	3616 06 00	16	17	17,5	17	22	15	0,028
8	3616 08 00	18	19	19,5	18,5	23,5	17	0,036
10	3616 10 00	22	27	24	21,5	26,5	21	0,067
12	3616 12 00	24	24	26	23	27	23	0,068
14	3616 14 00	27	27	29,5	25,5	29,5	25	0,089

## 3639 Equal bulkhead elbow

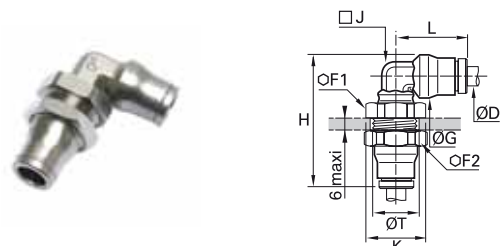

ØD		F1	F2	G	H	J	K	L	T	
4	3639 04 00	13	14	10	35	7	14	18	12,5	0,026
6	3639 06 00	16	17	12	40,5	8	17,5	21,5	15	0,039
8	3639 08 00	18	19	15	44	10	19,5	23,5	17	0,053
10	3639 10 00	22	27	17,5	51	12	24	29	21	0,080
12	3639 12 00	24	24	19,5	55	15	26	31	23	0,091
14	3639 14 00	27	27	21,5	59	16	29,5	34	25	0,114

## 3636 Female bulkhead connector, BSPP thread

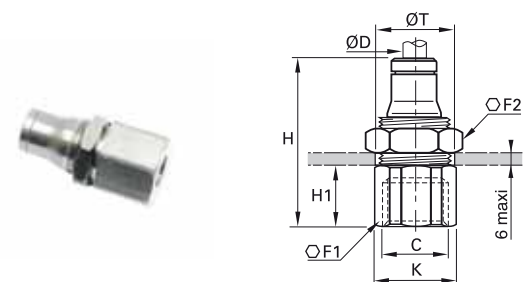

ØD	C		F1	F2	H	H1	K	T	
4	G1/8	3636 04 10	14	14	30,5	11	15	13	0,025
6	G1/8	3636 06 10	17	17	33	11	18,5	15	0,038
6	G1/4	3636 06 13	17	17	37	15	18,5	15	0,033
8	G1/8	3636 08 10	19	19	34	10,5	21	17	0,044
8	G1/4	3636 08 13	19	19	38	14,5	21	17	0,053
10	G3/8	3636 10 17	22	27	42,5	16	24	21	0,089
12	G3/8	3636 12 17	24	24	43	16	26	23	0,103
12	G1/2	3636 12 21	27	24	48,5	21,5	29,5	23	0,123

## 3606 Equal tube-to-tube connector

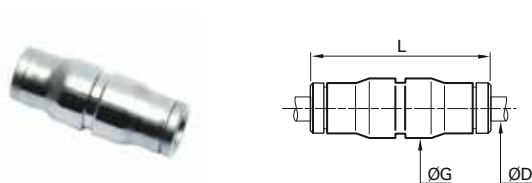

ØD		G	L	
4	3606 04 00	10	30,5	0,010
6	3606 06 00	12	36,5	0,017
8	3606 08 00	15	37,5	0,021
10	3606 10 00	17,5	47,5	0,036
12	3606 12 00	19,5	50	0,046
14	3606 14 00	21,5	52,5	0,052

## 3602 Equal elbow

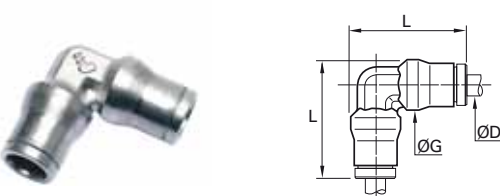

ØD		G	L	
4	3602 04 00	10	23	0,011
6	3602 06 00	12	28	0,017
8	3602 08 00	15	31	0,023
10	3602 10 00	17,5	37,5	0,036
12	3602 12 00	19,5	40,5	0,046
14	3602 14 00	21,5	45	0,058

## 3604 Equal tee

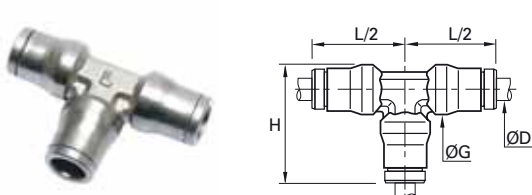

ØD		G	H	L/2	
4	3604 04 00	10	23	18	0,015
6	3604 06 00	12	28	21,5	0,023
8	3604 08 00	15	31	23,5	0,032
10	3604 10 00	17,5	37,5	29	0,049
12	3604 12 00	19,5	40,5	31	0,065
14	3604 14 00	21,5	45	34	0,078



# Plug-in Accessories

## 3666 Plug-in reducer

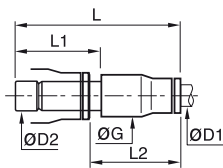

ØD1	ØD2		G	L	L1	L2	
4	6	3666 04 06	10	35	19,5	18	0,008
4	8	3666 04 08	10	35,5	20	18	0,010
6	8	3666 06 08	12	38	20	20,5	0,013
6	10	3666 06 10	12	43,5	25	21	0,015
8	10	3666 08 10	15	44	25	21,5	0,017
8	12	3666 08 12	15	44	26	20,5	0,019
10	12	3666 10 12	17,5	50	26	27	0,028
12	14	3666 12 14	19,5	53	28	28,5	0,039

## 3620 Double male stem connector

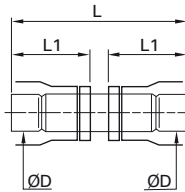

ØD		L	L1	
4	3620 04 00	31	14	0,002
6	3620 06 00	36,5	17	0,005
8	3620 08 00	37,5	17,5	0,007
10	3620 10 00	47,5	22,5	0,010
12	3620 12 00	49,5	23,5	0,014
14	3620 14 00	53	25	0,017

## 3668 Plug-in increaser

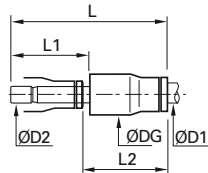

ØD1	ØD2		G	L	L1	L2	
6	4	3668 06 04	12	36	17	21,5	0,010

## 3622 Plug-in barbed connector

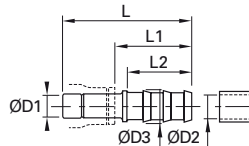

ØD1	ØD2	ØD3		L	L1	L2	
4	3,2	5	3622 04 53	40,5	27	22,5	0,003
4	5	7	3622 04 05	40,5	27	22,5	0,004
6	5	7	3622 06 05	43	27	22,5	0,006
8	6,3	8,3	3622 08 56	42	25	22,5	0,008
8	8	10	3622 08 08	44	27	22,5	0,009
10	6,3	8,3	3622 10 56	47,5	25,5	22,5	0,011
10	8	10	3622 10 08	47,5	25,5	22,5	0,011
12	8	10	3622 12 08	48,5	25,5	22,5	0,013
12	10	12	3622 12 10	48,5	25,5	22,5	0,014
12	12,5	14,5	3622 12 62	57	34	29,5	0,019
14	12,5	14,5	3622 14 62	57,5	33	29,5	0,022
14	14	16	3622 14 14	59,5	35	29,5	0,023

## 3667 Plug-in metric / imperial adaptor

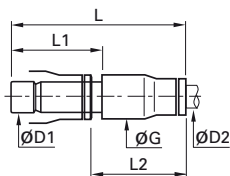

ØD1	ØD2		G	L	L1	L2	
6	1/4	3667 06 56	12,5	38,5	19,5	21	0,013
10	3/8	3667 10 60	17	49,5	25	27	0,027
12	1/2	3667 12 62	20	51	26	27,5	0,033

## 3626 Blanking plug

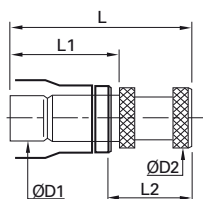

ØD1	ØD2		L	L1	L2	
4	6	3626 04 00	25,5	17	11,5	0,004
6	8	3626 06 00	30,5	19,5	13,5	0,009
8	10	3626 08 00	33	20	16	0,010
10	12	3626 10 00	40	25	18	0,015
12	14	3626 12 00	43	26	20	0,025
14	16	3626 14 00	47	28	22,5	0,029

# Nickel-Plated Brass Accessories and Plugs

Working pressure : 60 bar maximum - Working temperature : -40°C to +150°C / Available threads : M5 to 3/4.  
The accessories are in conformity with RoHS standards.

## 0912 Equal female stud elbow, BSPP and metric thread

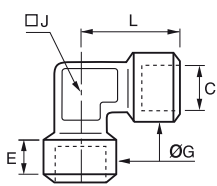

C		E	G	J	L	
M5x0,8	0912 00 19	4	8	9	11	0,006
G1/8	0912 00 10	8	13	10	21	0,020
G1/4	0912 00 13	11	17	13	25,5	0,040
G3/8	0912 00 17	11,5	21	17	28	0,059
G1/2	0912 00 21	14	26	21	33,5	0,100
G3/4	0912 00 27	15	31	27	36,5	0,154

## 0913-0921 Equal female stud elbow BSPP, male BSPT and metric thread

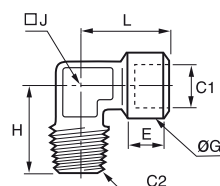

C1	C2		E	G	H	J	L	
M5x0,8	M5x0,8	0921 00 19	4	8	11	9	11	0,006
G1/8	R1/8	0913 00 10	8	13	18,5	10	21	0,017
G1/4	R1/4	0913 00 13	11	17	23,5	13	25,5	0,033
G3/8	R3/8	0913 00 17	11,5	21	26	17	28	0,050
G1/2	R1/2	0913 00 21	14	26	31	21	33,5	0,085
G3/4	R3/4	0913 00 27	15	31	35	27	36,5	0,122

## 0915 Equal female tee, BSPP and metric thread

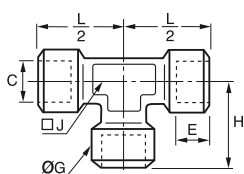

C		E	G	H	J	L/2	
M5x0,8	0915 00 19	4	8	11	9	11	0,009
G1/8	0915 00 10	8	13	21	10	21	0,028
G1/4	0915 00 13	11	17	25,5	13	25,5	0,056
G3/8	0915 00 17	11,5	21	28	17	28	0,083
G1/2	0915 00 21	14	26	33,5	21	33,5	0,139
G3/4	0915 00 27	15	31	36,5	27	36,5	0,215

## 0916-0923 Male stud branch tee, female BSPP, male BSPT and metric thread

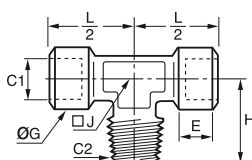

C1	C2		E	G	H	J	L/2	
M5x0,8	M5x0,8	0923 00 19	4	8	11	9	11	0,009
G1/8	R1/8	0916 00 10	8	13	18,5	10	21	0,025
G1/4	R1/4	0916 00 13	11	17	23,5	13	25,5	0,049
G3/8	R3/8	0916 00 17	11,5	21	26	17	28	0,076
G1/2	R1/2	0916 00 21	14	26	31	21	33,5	0,125
G3/4	R3/4	0916 00 27	15	31	36,5	27	36,5	0,187

## 0911 Equal 'Y', female BSPP, male BSPT

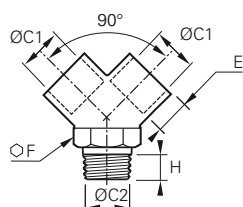

C1	C2		E	F	G	
G1/8	R1/8	0911 00 10	8	13	12	0,022
G1/4	R1/4	0911 00 13	11	17	14	0,039
G3/8	R3/8	0911 00 17	11,5	20	16	0,053
G1/2	R1/2	0911 00 21	14	25	19	0,107

## 0908 Equal female cross, BSPP

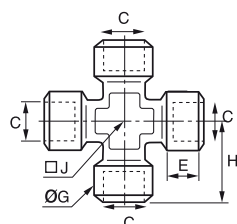

C		E	G	H	J	
G1/8	0908 00 10	8	13	21	10	0,035
G1/4	0908 00 13	11	17	25,5	13	0,072
G3/8	0908 00 17	11,5	21	28	17	0,103
G1/2	0908 00 21	14	26	33,5	21	0,182

# Nickel-Plated Brass Accessories and Plugs

## 0192 Straight male adaptor, BSPT to BSPP

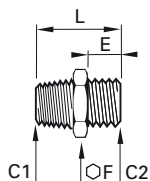

C1	C2		E	F	L	
R1/8	G1/4	0192 10 13	9,5	17	23,5	0,019
R1/4	G1/4	0192 13 13	9,5	17	27,5	0,024
R1/4	G1/2	0192 13 21	27	27	31,5	0,067
R3/8	G1/4	0192 17 13	9,5	17	45	0,025
R3/8	G1/2	0192 17 21	27	27	31,5	0,061
R1/2	G1/2	0192 21 21	27	27	34	0,060

## 0919 Internal hexagon head, BSPP and M5

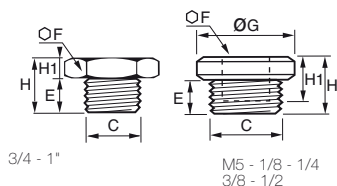

C		ØG	E	F	H	H1	
M5x0,8	0919 00 19	8	4	2,5	7,5	3,5	0,001
G1/8	0919 00 10	15	6	3	10	4	0,008
G1/4	0919 00 13	18	8	6	12	4	0,013
G3/8	0919 00 17	21	9	8	13	4	0,021
G1/2	0919 00 21	25	10	10	14,5	4,5	0,036
G3/4	0919 00 27	-	11	30	17	6	0,044
G1"	0919 00 34	-	13	38	19	6	0,084

## 3610 Coloured release button covers (anodized aluminium)



ØD			
6	3610 06 02	3610 06 03	0,001
8	3610 08 02	3610 08 03	0,001
10	3610 10 02	3610 10 03	0,001
12	3610 12 02	3610 12 03	0,001

# Associated Tubes for LF 3600 Applications

Material	Part Number	Diameter (mm)	Pressure (bar)	Temperature (°C)	Maximum pressure at maximum temperature	Applications	Advantages
Polyurethane polyester	1025U - 1100U	3 to 14	5 to 14	70	3 to 7	Pneumatics	Flexible and resistant UV resistant with ISO 4892 silicone free, RoHS, halogen free, REACH
Polyurethane polyether	1025U .. R - 1100U ..R	4 to 14	8 to 14	70	3 to 7	Food process	FDA, CE (minimum flow) UV resistant with ISO 4892 silicone free, RoHS, halogen free REACH
Semi-rigid polyamide	1025P - 1100P	3 to 16	12 to 55	80	12 to 25	Pneumatics	UV resistant with ISO 4892, silicone free, RoHS, halogen free REACH
Rigid polyamide	1025L	4 to 10	32 to 58	80	15 to 28	Pneumatics and lubrication systems	High pressures, silicone free, RoHS, halogen free, REACH
Advanced PE	1025Y - 1100Y	4 to 12	11 to 16	95	3	Food process	FDA, NSF51, 61, 42/58 DI 2002/72 EC silicone free, RoHS, halogen free, REACH
FEP	1005T - 1025T	4 to 12	10 to 22	150	1 to 6	Food process	FDA, UL94V0, UV resistant silicone free, RoHS, REACH
Antistatic Polyurethane	1100U..A01	3 to 12	8 to 14	70	3 to 7	Car industry - Electronics	ATEX, resistivity (103 to 106 ohm), silicone free, RoHS, REACH
Anti-spark Single layer polyurethane	1025U..K - 1100U..K	4 to 12	10 to 14	70	6 to 8	Car industry	UL94V0 silicone free, RoHS, REACH
Anti-spark polyamide with PVC coating	1025P..V -1100P..V	6 to 12	15 to 36	80	7 to 18	Car industry	UL94V0, resistance to high pressures, silicone free, RoHS, REACH

In case of use of the tubing at high temperature and / or pressure, the use of a ferrule (type : 0127) is highly recommended.

Parker Legris Connectic offers a comprehensive range of instant fittings and tubes; please consult our general catalogue or visit [www.legris.com](http://www.legris.com) or [www.parkerconnectic.com](http://www.parkerconnectic.com).

# Parker Worldwide

## Europe, Middle East, Africa

**AE – United Arab Emirates,**  
Dubai

Tel: +971 4 8127100  
parker.me@parker.com

**AT – Austria,** Wiener Neustadt  
Tel: +43 (0)2622 23501-0  
parker.austria@parker.com

**AT – Eastern Europe,** Wiener  
Neustadt  
Tel: +43 (0)2622 23501 900  
parker.easteurope@parker.com

**AZ – Azerbaijan,** Baku  
Tel: +994 50 2233 458  
parker.azerbaijan@parker.com

**BE/LU – Belgium,** Nivelles  
Tel: +32 (0)67 280 900  
parker.belgium@parker.com

**BY – Belarus,** Minsk  
Tel: +375 17 209 9399  
parker.belarus@parker.com

**CH – Switzerland,** Etoy  
Tel: +41 (0)21 821 87 00  
parker.switzerland@parker.com

**CZ – Czech Republic,** Klecany  
Tel: +420 284 083 111  
parker.czechrepublic@parker.com

**DE – Germany,** Kaarst  
Tel: +49 (0)2131 4016 0  
parker.germany@parker.com

**DK – Denmark,** Ballerup  
Tel: +45 43 56 04 00  
parker.denmark@parker.com

**ES – Spain,** Madrid  
Tel: +34 902 330 001  
parker.spain@parker.com

**FI – Finland,** Vantaa  
Tel: +358 (0)20 753 2500  
parker.finland@parker.com

**FR – France,** Contamine s/Arve  
Tel: +33 (0)4 50 25 80 25  
parker.france@parker.com

**GR – Greece,** Athens  
Tel: +30 210 933 6450  
parker.greece@parker.com

**HU – Hungary,** Budapest  
Tel: +36 1 220 4155  
parker.hungary@parker.com

**IE – Ireland,** Dublin  
Tel: +353 (0)1 466 6370  
parker.ireland@parker.com

**IT – Italy,** Corsico (MI)  
Tel: +39 02 45 19 21  
parker.italy@parker.com

**KZ – Kazakhstan,** Almaty  
Tel: +7 7272 505 800  
parker.easteurope@parker.com

**NL – The Netherlands,** Oldenzaal  
Tel: +31 (0)541 585 000  
parker.nl@parker.com

**NO – Norway,** Asker  
Tel: +47 66 75 34 00  
parker.norway@parker.com

**PL – Poland,** Warsaw  
Tel: +48 (0)22 573 24 00  
parker.poland@parker.com

**PT – Portugal,** Leca da Palmeira  
Tel: +351 22 999 7360  
parker.portugal@parker.com

**RO – Romania,** Bucharest  
Tel: +40 21 252 1382  
parker.romania@parker.com

**RU – Russia,** Moscow  
Tel: +7 495 645-2156  
parker.russia@parker.com

**SE – Sweden,** Spånga  
Tel: +46 (0)8 59 79 50 00  
parker.sweden@parker.com

**SK – Slovakia,** Banská Bystrica  
Tel: +421 484 162 252  
parker.slovakia@parker.com

**SL – Slovenia,** Novo Mesto  
Tel: +386 7 337 6650  
parker.slovenia@parker.com

**TR – Turkey,** Istanbul  
Tel: +90 216 4997081  
parker.turkey@parker.com

**UA – Ukraine,** Kiev  
Tel: +380 44 494 2731  
parker.ukraine@parker.com

**UK – United Kingdom,** Warwick  
Tel: +44 (0)1926 317 878  
parker.uk@parker.com

**ZA – South Africa,** Kempton Park  
Tel: +27 (0)11 961 0700  
parker.southafrica@parker.com

## North America

**CA – Canada,** Milton, Ontario  
Tel: +1 905 693 3000

**US – USA,** Cleveland  
Tel: +1 216 896 3000

## Asia Pacific

**AU – Australia,** Castle Hill  
Tel: +61 (0)2-9634 7777

**CN – China,** Shanghai  
Tel: +86 21 2899 5000

**HK – Hong Kong**  
Tel: +852 2428 8008

**IN – India,** Mumbai  
Tel: +91 22 6513 7081-85

**JP – Japan,** Tokyo  
Tel: +81 (0)3 6408 3901

**KR – South Korea,** Seoul  
Tel: +82 2 559 0400

**MY – Malaysia,** Shah Alam  
Tel: +60 3 7849 0800

**NZ – New Zealand,** Mt Wellington  
Tel: +64 9 574 1744

**SG – Singapore**  
Tel: +65 6887 6300

**TH – Thailand,** Bangkok  
Tel: +662 717 8140

**TW – Taiwan,** Taipei  
Tel: +886 2 2298 8987

## South America

**AR – Argentina,** Buenos Aires  
Tel: +54 3327 44 4129

**BR – Brazil,** Sao Jose dos Campos  
Tel: +55 12 4009 3500

**CL – Chile,** Santiago  
Tel: +56 2 623 1216

**MX – Mexico,** Apodaca  
Tel: +52 81 8156 6000

**VE – Venezuela,** Caracas  
Tel: +58 212 238 5422

European Product Information Centre  
Free phone: 00 800 27 27 5374  
(from AT, BE, CH, CZ, DE, DK, EE, ES, FI,  
FR, IE, IL, IS, IT, LU, MT, NL, NO, PL, PT, RU,  
SE, SK, UK, ZA)



Fluid System Connectors Europe  
**Parker Hannifin France SAS**  
**Parker Hannifin Corporation**  
CS 46911 - 74 rue de Paris  
35069 Rennes  
phone : +33 (0)2 99 25 55 00  
fax : +33 (0)2 99 25 55 99  
www.parkerconnectic.com